

Main Module

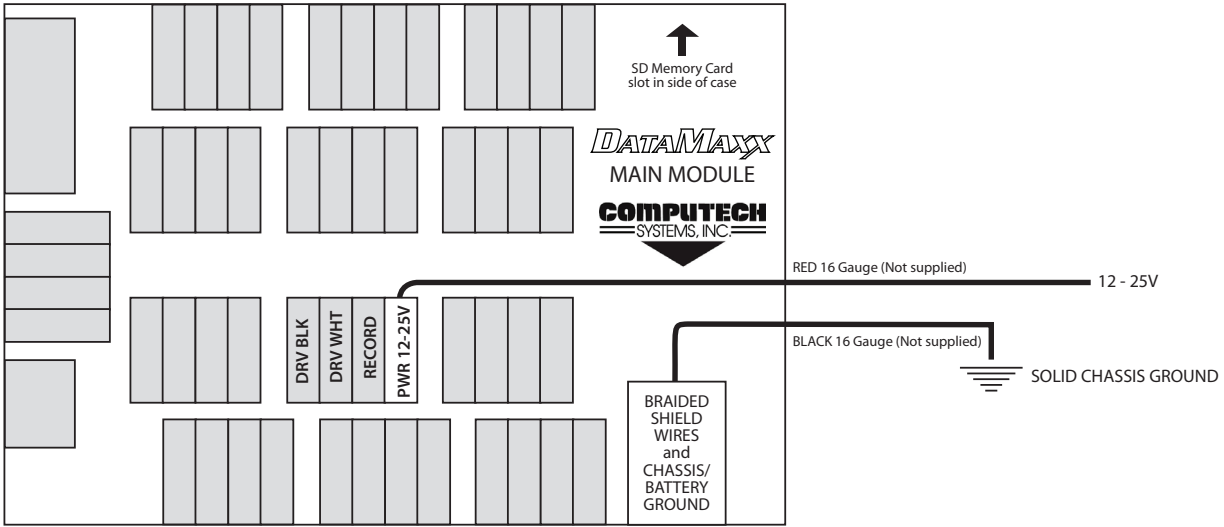

LCD Module

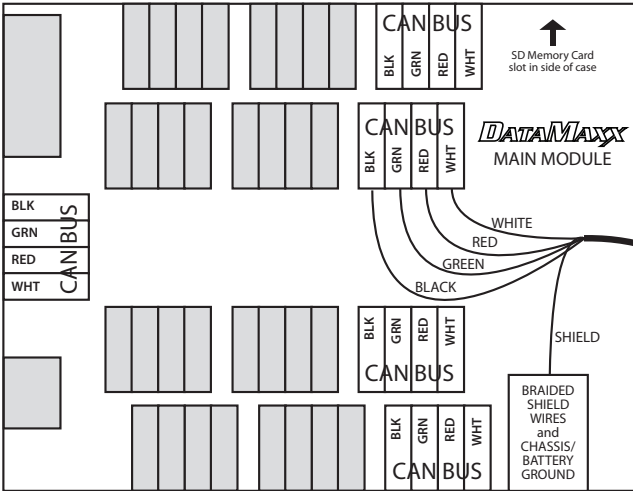

* The LCD dash can be connected to any one of the CAN bus terminals.

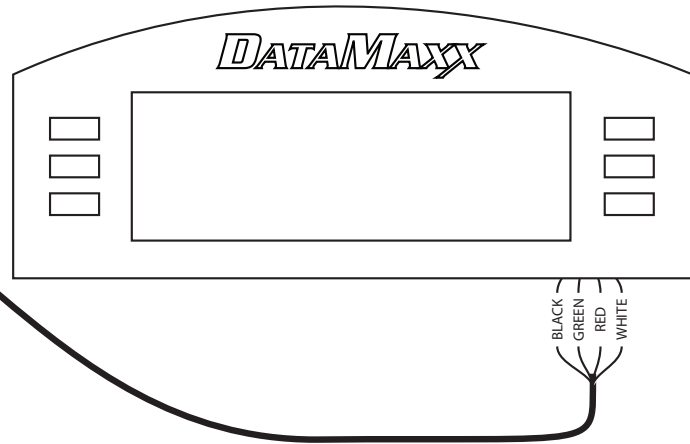

Analog Module

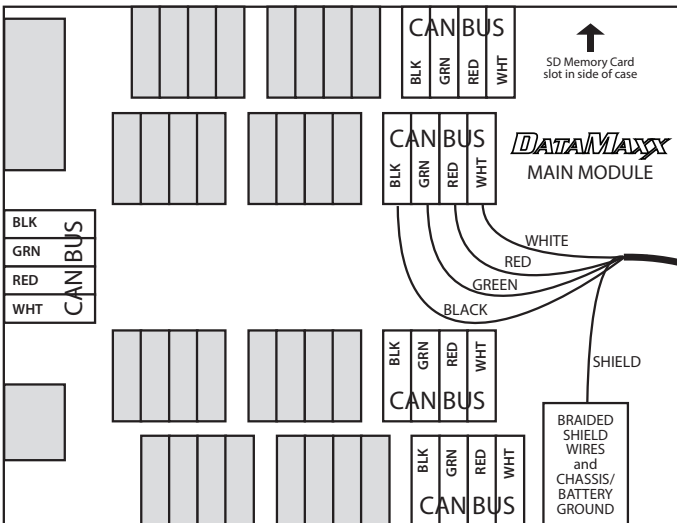

* This analog module can be connected to any one of the CAN bus terminals

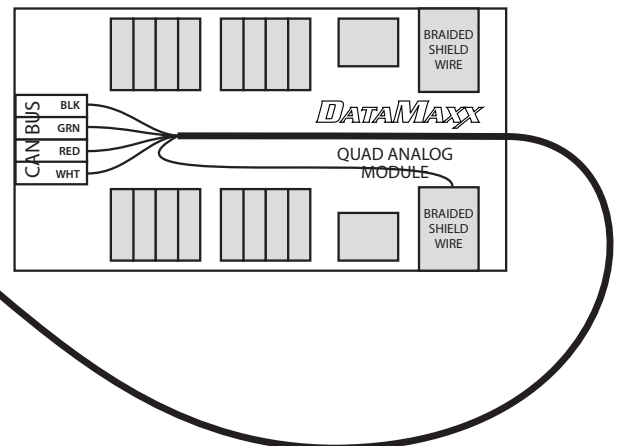

EGT Module

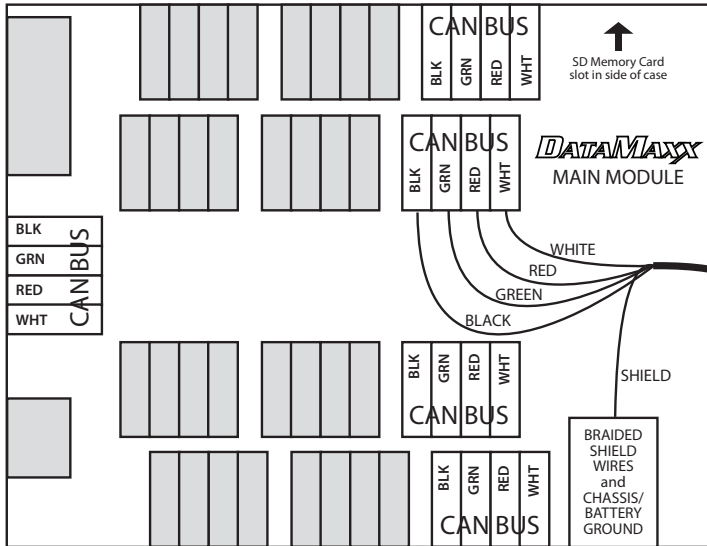

* This module can be connected to any one of the CAN bus terminals.

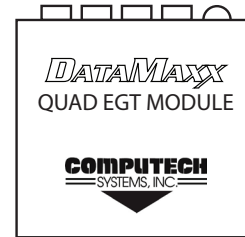

SD Card Reader

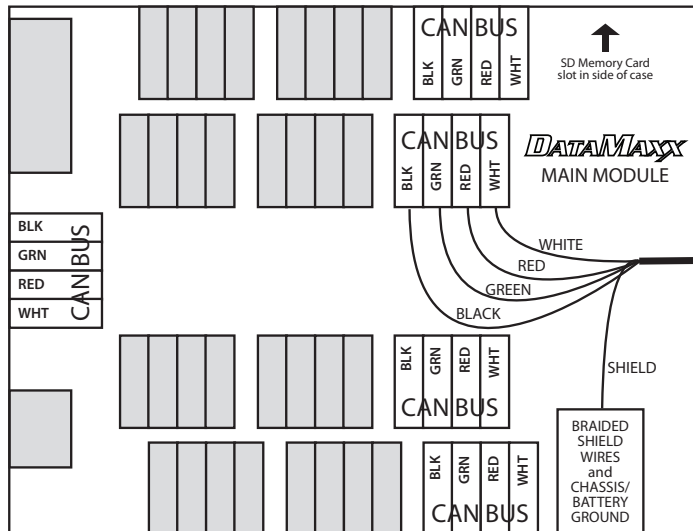

* This module can be connected to any one of the CAN bus terminals.

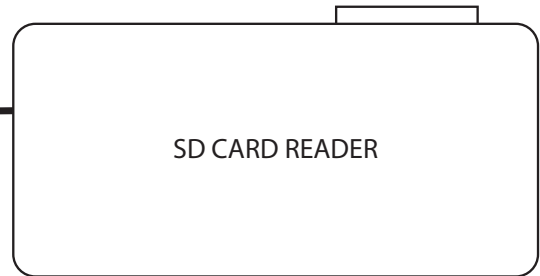

Record Switch

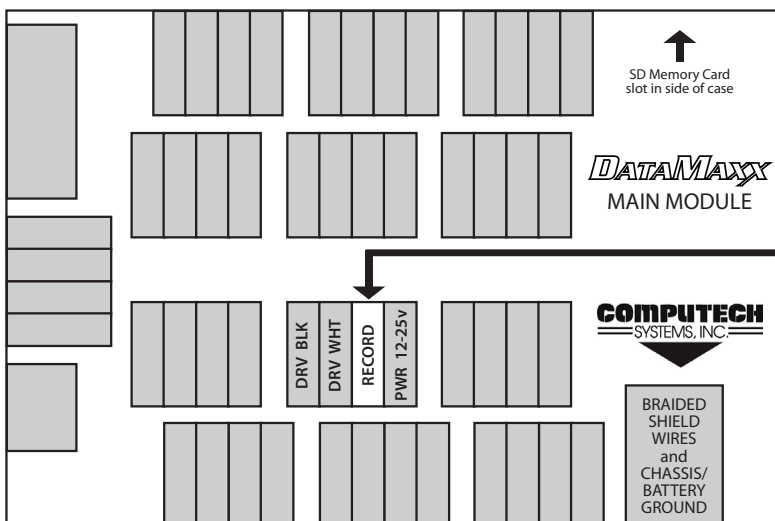

18 Gauge (Not supplied)

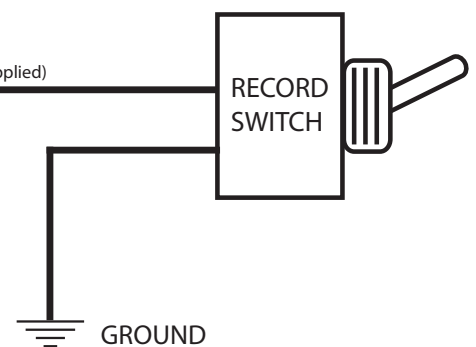

Engine RPM

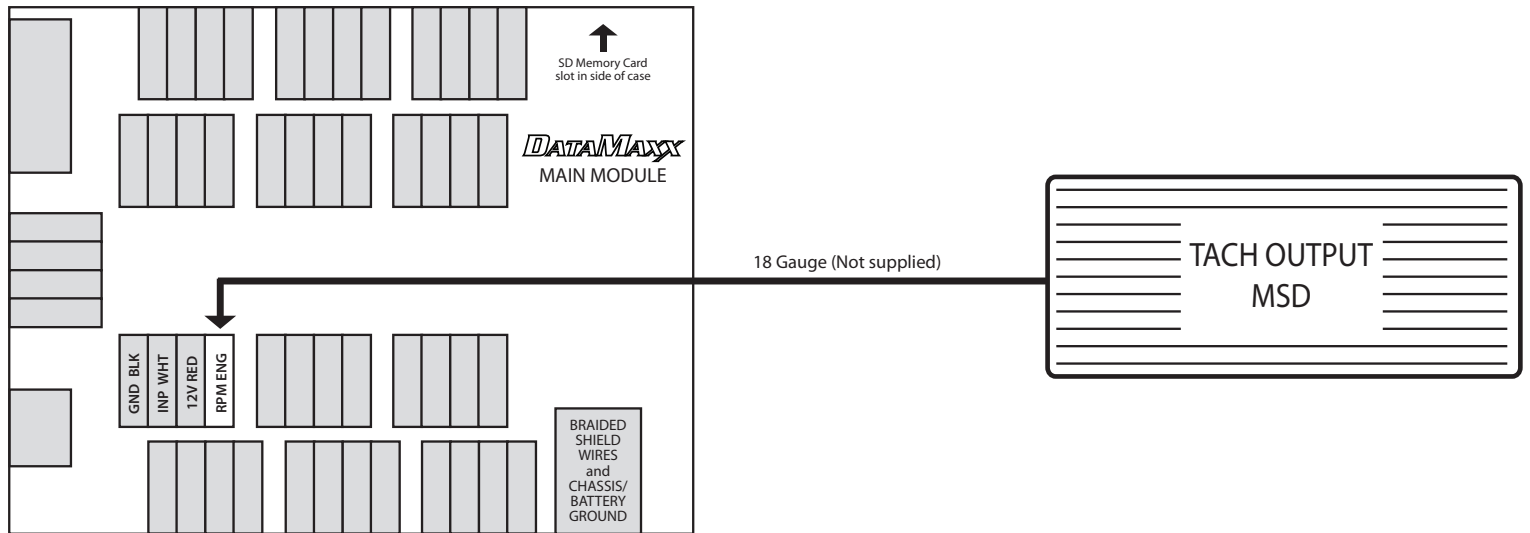

Driveshaft RPM

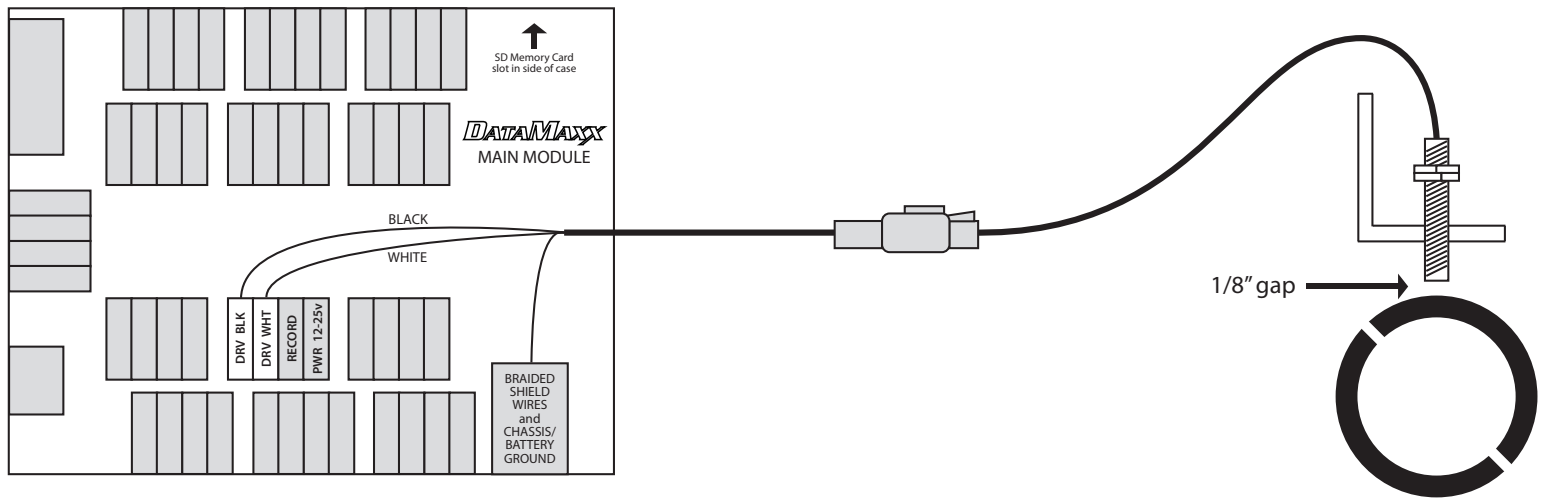

Input Shaft RPM

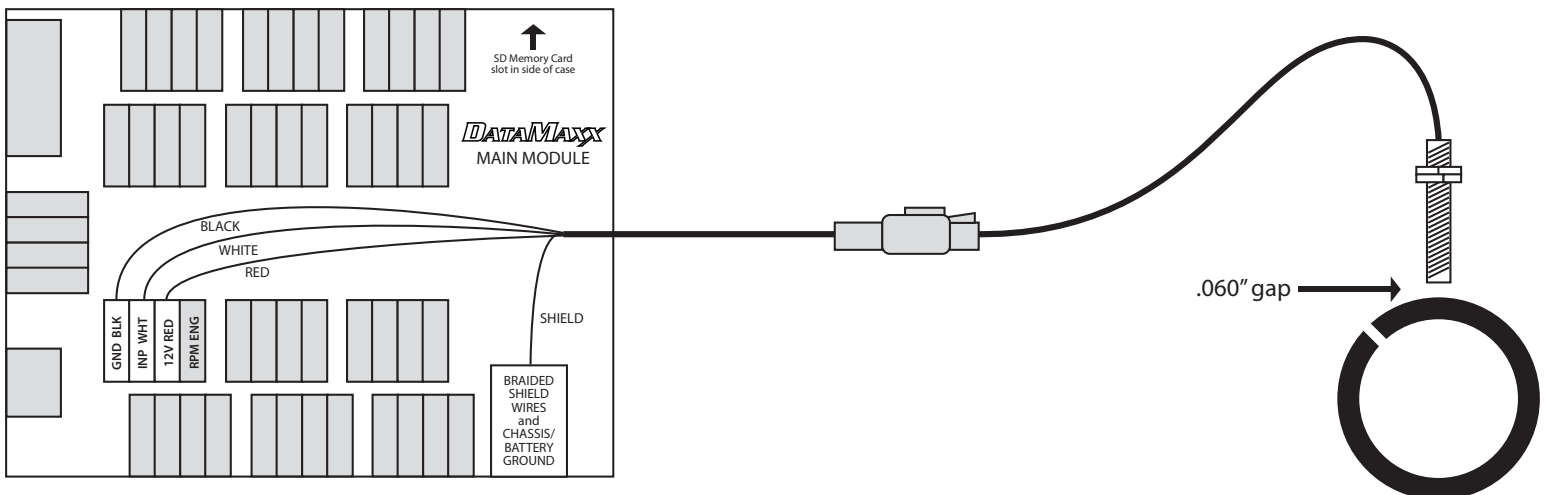

Pressure Sensor

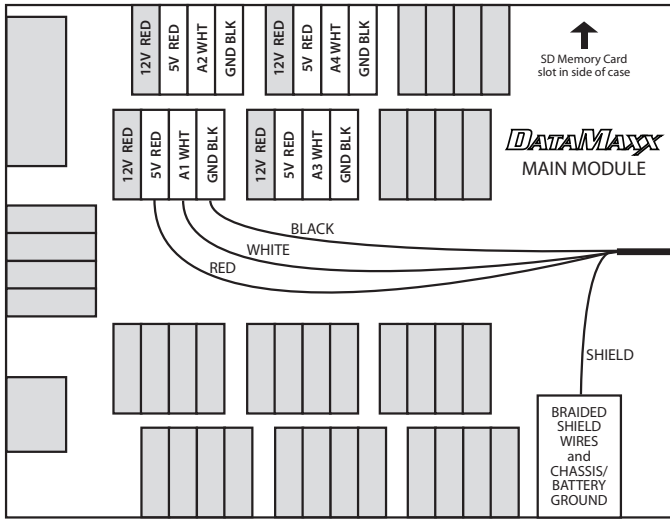

* This sensor can be placed within any of the analog ports.

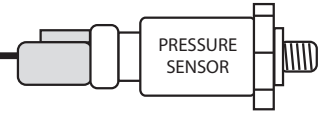

EGT Probe

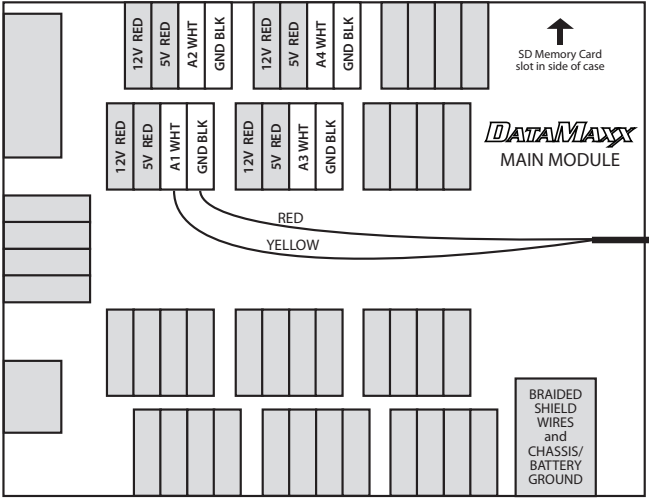

* This sensor can be placed within any of the analog ports.

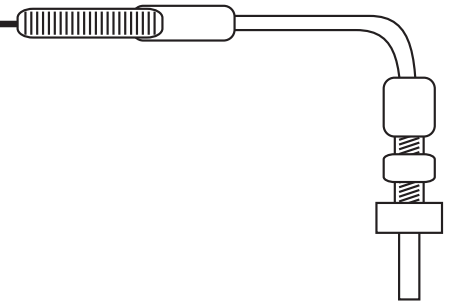

Low Range Temp

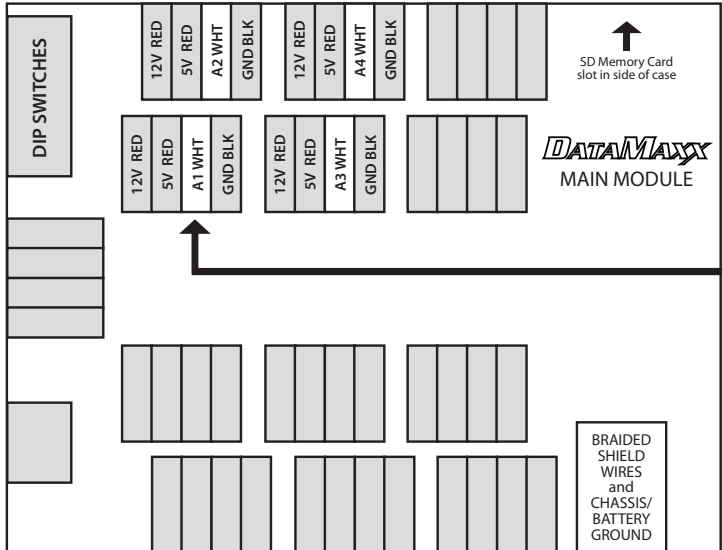

* Associated RTD & DIP switch must be turned on.
This sensor can be placed within any of the analog

18 Gauge (Not Supplied)

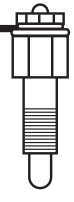

Accelerometer

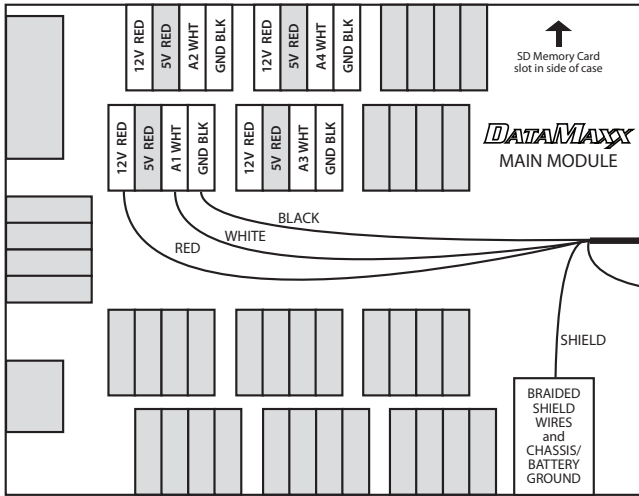

* This sensor can be placed within any of the analog ports.

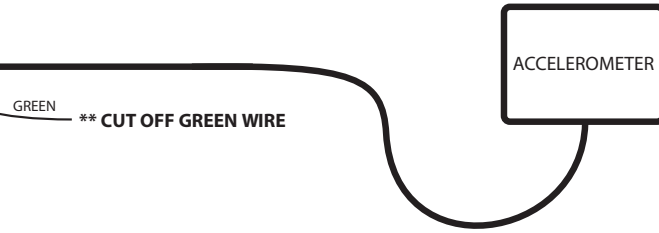

Oxygen Sensor

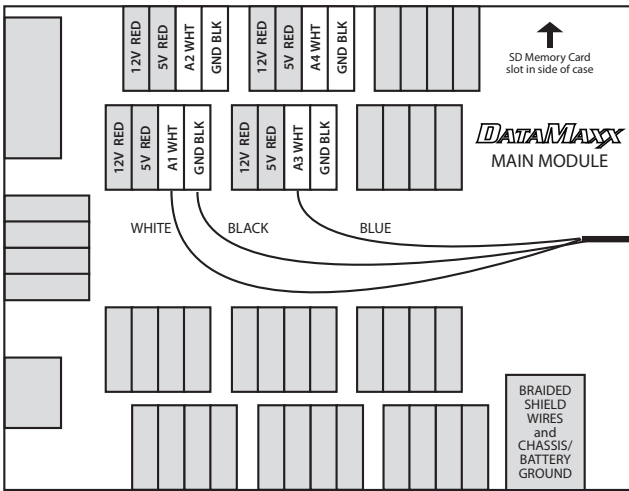

* This sensor can be placed within any of the analog ports.

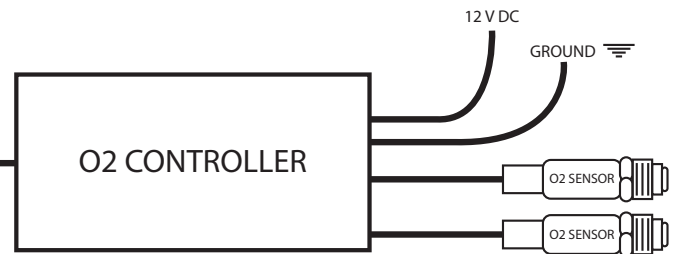

Suspension Sensor

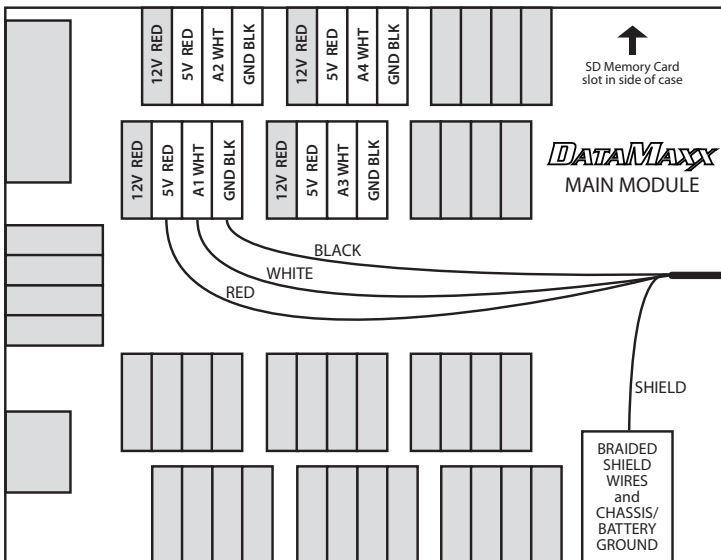

* This sensor can be placed within any of the analog ports.

